



Shadowspec
SERENITYTM
Single-Canopy Rotating Cantilever Umbrella



Precision Engineered Ambience



Fabric
Warranty*
BEST-IN-CLASS



Frame
Warranty*
BEST-IN-CLASS



Trusted for
over 25 years



Hand-built in
New Zealand



Marine
Grade

SHADOWSPEC SERENITY™ Single Canopy Rotating Cantilever Umbrella

Patented & Trademarked Technology



SHADOWLIFT™

Gas-assisted deployment for an easy lift.



SHADOWGLIDE™

Engineered to open or close in 5 seconds.



SHADOWHUB™

LED light technology built-in and app controlled.



SHADOWLOCK™

Integrated security and wind-protection.

Canopy



Fabric Warranty*
BEST-IN-CLASS

Quick-Ship Stock Colors



Oyster



Alpine Stone

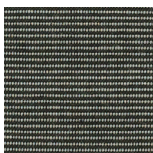

Charcoal Tweed

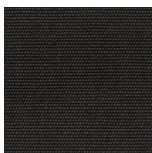

Black

Special-Order Colors**

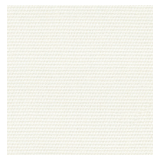

Natural



Storm



Charcoal



Slate

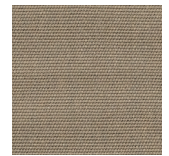

Taupe

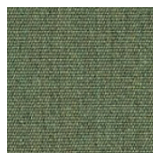

Fern

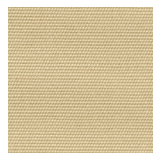

Linen

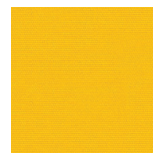

Sunflower Yellow

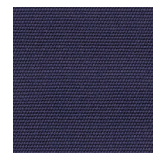

Captain Navy

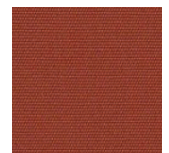

Terracotta

RECASENS
BCN 1886

 **sunbrella®**

**Special-Order Colors are non-stock and will incur an additional lead time and surcharge. Full Sunbrella range is available as a custom color option.



Marine Grade



Solution-dyed, High Color Fastness



UV and Fade Resistant



UPF 80 UV Protection



Eco-friendly Production



Breathable Weave



Mold and Mildew Resistant



Oil and Stain Repellent



Easy Clean



Water Resistant



Chlorine Resistant



Tear Resistant

Size & Configuration

SQUARE

8' | 2.5m

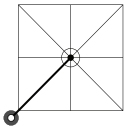

SQUARE

10' | 3.0m

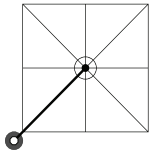

OCTAGON

11' | 3.5m

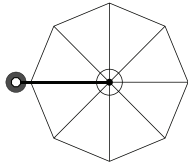

OCTAGON

13' | 4.0m

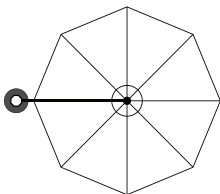

All sizings and conversions are approximate and subject to change without notice. Refer to specsheets for exact, up-to-date measurements.

Features



EASY OPEN & CLOSE

Umbrella deployment system with no winding or cables.



MARINE GRADE

No-rust, 316 Stainless Steel Spigot.

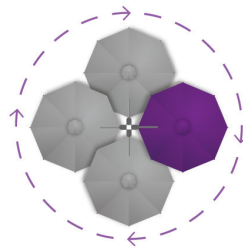

FOLLOW THE SUN

Enjoy the 360° rotation for all-day-shade.

Accessories



LED LIGHT CONTROL

Power your light with the optional Smart Battery or Hardwire Kit.



PROTECTION COVER

Recommended, optional care and protection for your umbrella.



CASTOR WHEELS

Optional heavy-duty wheels so you can move your Free-standing Base.

Mounting Options

SURFACE PLATE

For deck, patio and concrete mounting. (316 stainless steel)



IN-GROUND ANCHOR

For mounting with a concrete footing.



WALL MOUNT BRACKET

For when ground mounting isn't possible. (316 stainless steel)



FREE-STANDING BASE + ALUMINUM BASE COVER

For complete customized manoeuvrability.



Note: Fastenings are not supplied for the Surface Plate or Wall Mount Bracket..

Optional Castor Wheels available. Note - Concrete pavers are required for ballast (not supplied).

Dimensions

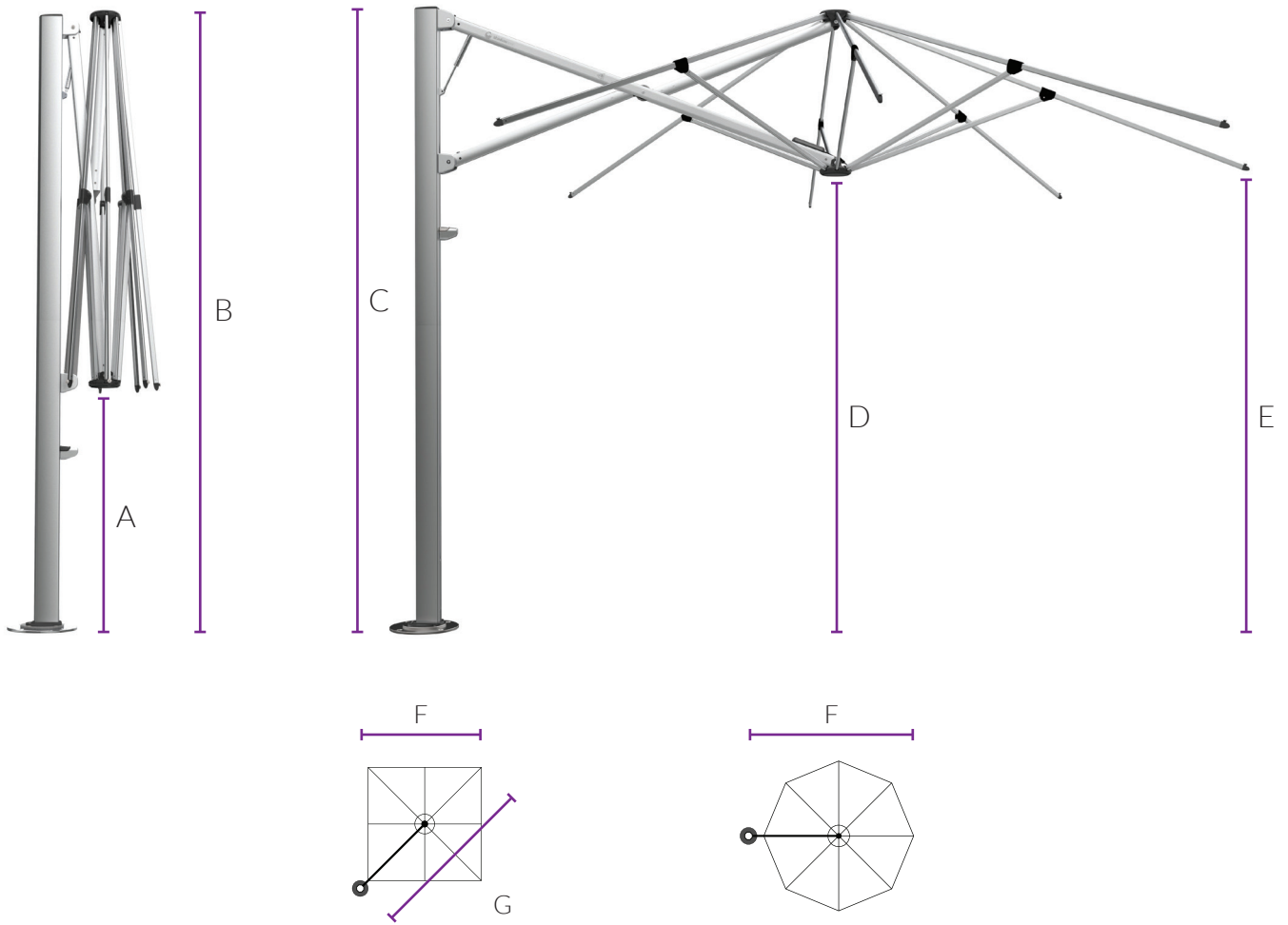

Diagram Legend

	8'	2.5m	10'	3.0m	11'	3.5m	13'	4.0m	
A	Ground to central frame hub when closed***	2'10"	860mm	2'1"	620mm	3'7"	1079mm	2'10"	866mm
B	Total height to top of canopy***	9'6"	2900mm	9'3"	2824mm	9'9"	2975mm	9'6"	2899mm
C	Height of umbrella to top of mast cap***	9'6"	2908mm	9'6"	2908mm	9'7"	2908mm	9'6"	2908mm
D	Ground to central frame hub when open***	7'0"	2130mm	6'9"	2054mm	7'3"	2205mm	7'0"	2128mm
E	Ground to lower outer edge of canopy***	7'3"	2222mm	7'3"	2219mm	7'4"	2237mm	7'2"	2172mm
F	Centre of Spigot to outside edge of canopy	8'8"	2646mm	9'10"	2973mm	11'4"	3447mm	12'10"	3923mm
G	Diagonal from centre of mast to corner	12'3"	3742mm	13'10"	4205mm	N/A	N/A	N/A	N/A

***Free-Standing Base installations will add 6" | 165mm to the height and surface plates will add 1/2" | 12mm to the height. Adding the optional Castor Wheels to the Free-standing Base will increase height a further 2-3" | 45-80mm to the height. All sizings and conversions are approximate and subject to change without notice. Refer to specsheets for exact, up-to-date measurements.



shadowspec
umbrellas with distinction